















## VOLCANO WLTh/WPTh 12

Wkłady z płaszczem wodnym do układu zamkniętego  
 Inserts with water jacket for closed heating system  
 Топка с водной рубашкой к заключоных системов

-  82 (%)
-  ≤ 0,08 (%)
-  240 (C°)
-  12 (Pa)
-  200 (mm)
-  drewno drzew liściastych  
hardwood  
твердая древесина
-  tak  
yes  
oui  
да
-  tak  
yes  
oui  
да
-  12 (kW)  
w tym 6 (kW)  
moc do obiegu  
wodnego
-  0,010 (g/m<sup>3</sup>)
-  365 (kg)
-  10 g/s
-  150 (mm)
-  50 (cm)
-  CLING



VOLCANO WLTh 12

VOLCANO WPTh 12

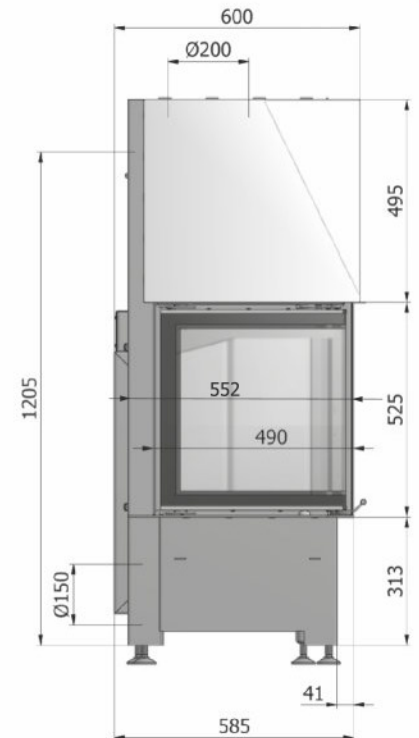
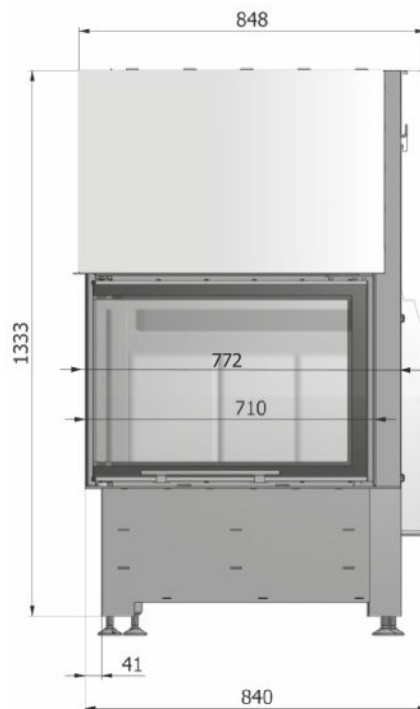
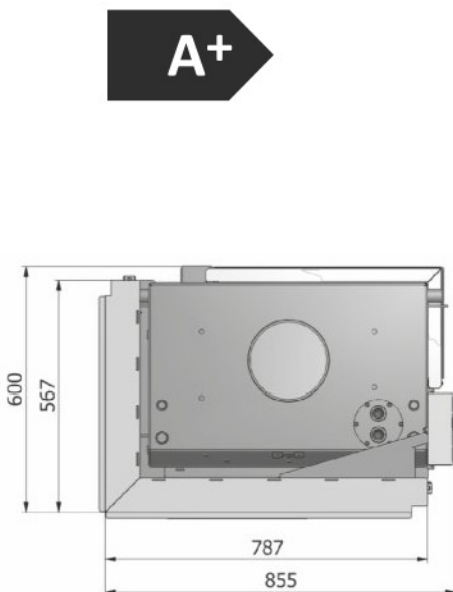

**A+**